



## CHROMABOND® Vacuum manifold

### ★ Key features

- For the simultaneous preparation of up to 12, 16 or 24 samples
- Replacement parts and accessories for special applications

### Vacuum manifold for 12 columns

- ① Rectangular glass cabinet; 2 sizes available: small for up to 12 CHROMABOND® columns or CHROMAFIX® cartridges; large for up to 16 CHROMABOND® LV columns or up to 24 CHROMABOND® columns or CHROMAFIX® cartridges (depending on lid)
- ② Polypropylene lid
- ③ Vacuum gauge for pressure reading
- ④ Control valve for adjustment of vacuum
- ⑤ Replaceable valves for vacuum control of individual SPE columns
- ⑥ Variable rack with exchangeable partitions, which accept a wide variety of vessels like test tubes, measuring flasks, scintillation vials, autosampler vials, plastic vials etc.
- ⑦ CHROMABOND® LV columns with 15 mL sample reservoir for medium size samples
- ⑧ Polypropylene sample reservoirs (30 or 70 mL)\*
- ⑨ Adapter for sample reservoirs\*
- ⑩ CHROMABOND® tubing adapters

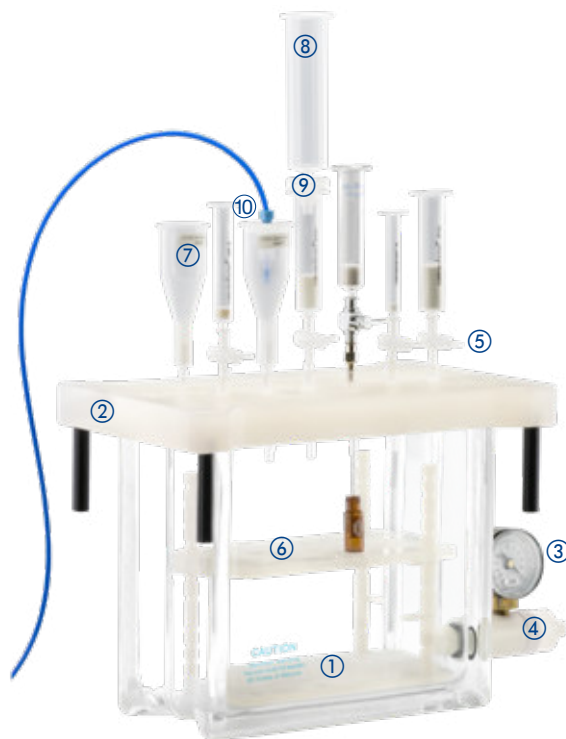

Full description and manual can be downloaded at [www.mn-net.com](http://www.mn-net.com)

### Ordering information

Description	Pack of	REF
<b>Vacuum manifold complete</b>		
consists of glass cabinet with lid and lid gasket, removable needles on lower side of lid, vacuum gauge, control valve, valves and caps, variable rack:		
for up to 12 columns or cartridges (including PP tank)	1	730150
for up to 16 LV columns	1	730360
for up to 24 columns or cartridges	1	730151
<b>Glass cabinets without accessories ①</b>		
for 12 columns	1	730173
for 16 LV or 24 columns (large)	1	730174
<b>Lids with gaskets ②</b>		
for 12 columns (including Luer fittings and valves ⑤)	1	730175
for 16 LV columns (including Luer fittings and valves ⑤)	1	730365
for 24 columns (including Luer fittings and valves ⑤)	1	730176
Gaskets for lid, for 12 columns	2	730177
Gaskets for lid, for 16 or 24 columns	2	730178

\* Ordering information see on page 67.

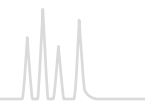

## Ordering information

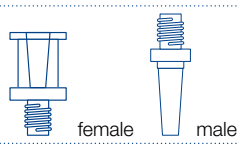
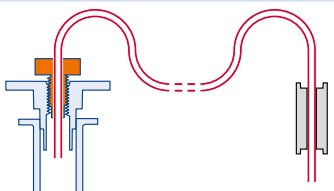
Description	Pack of	REF
<b>General accessories for vacuum manifolds</b>		
Luer stoppers for vacuum manifold, blue	12	730194
Luer fittings for lid, female	12	730183.12
Luer fittings for lid, male	12	730184.12
		
Valves, plastic ⑤	12	730185
Stainless steel needles	12	730152
Polypropylene needles	12	730154
PP tanks for vacuum manifold for 12 columns (not available for 16- or 24-position manifold)	2	730233
Vacuum gauge, complete with accessories ③ + ④	1	730179
<b>Drying attachment and collecting racks</b>		
for evaporation of eluates (application see below)		
Drying attachment, with 12 positions ⑪	1	730187
Drying attachment, with 16 positions	1	730990
Drying attachment, with 24 positions	1	730188
Collecting rack for 12 columns ⑥	1	730157
Collecting rack for 16 LV columns	1	730366
Collecting rack for 24 columns	1	730153
<b>Products for protection from cross contamination</b>		
Valve, brass, tarnished	1	730189.1
Valves, as above	12	730189.12
Stainless steel connectors	12	730106
PTFE connectors	12	730564
<b>Tubing adapters for application of large sample volumes ⑩</b>		
for 3 and 6 mL glass columns	4	730387
for 1, 3 and 6 mL polypropylene columns	4	730243
for 15, 45 and 70 mL polypropylene columns (material: PTFE tube length approx. 1 m)	4	730386
		

## Protection from cross contamination

For special applications which require maximum protection from cross contamination we supply chrome-plated brass valves and stainless steel or PTFE connectors. Their application is shown on the right side. These special connectors are fitted through the lid; thus the sample only has contact with the inert connector and can flow directly into the receptacle.

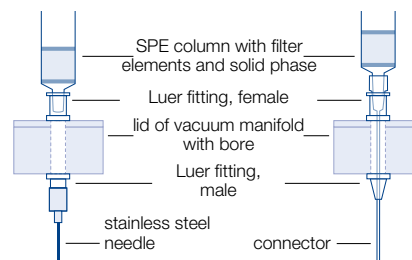

## Drying attachment

If the eluate has to be evaporated, this can be performed with the so-called drying attachment ⑪. This special lid has a gas connector ⑫ on one side, from which the gas is fed simultaneously to the 12, 16, or 24 stations ⑬. Thus 12, 16, or 24 eluates can be evaporated simultaneously by just changing the lid and applying a stream of inert gas, e.g., nitrogen.





For individual packing of SPE columns with CHROMABOND® adsorbents

Ordering information		
Description	Pack of	REF
Empty polypropylene columns with 2 PE filter elements, 1 mL	100	730159
Empty polypropylene columns with 2 PE filter elements, 3 mL	50	730160
Empty polypropylene columns with 2 PE filter elements, 6 mL	30	730161
Empty polypropylene columns with 2 PE filter elements, 15 mL	20	730230
Empty polypropylene columns with 2 PE filter elements, 30 mL	20	730380
Empty polypropylene columns with 2 PE filter elements, 45 mL	20	730355
Empty polypropylene columns with 2 PE filter elements, 70 mL	20	730158
Empty polypropylene columns with 2 PE filter elements, 150 mL	20	730474
PE filter elements for polypropylene columns 1 mL	250	730164
PE filter elements for polypropylene columns 3 mL	250	730162
PE filter elements for polypropylene columns 6 mL	250	730163
PE filter elements for polypropylene columns 15 mL	250	730351
PE filter elements for polypropylene columns 30 mL	250	730034
PE filter elements for polypropylene columns 45 mL	250	730356
PE filter elements for polypropylene columns 70 mL	250	730026
PE filter elements for polypropylene columns 150 mL	250	730475
Empty glass columns with 2 glass fiber filter elements, 3 mL	50	730171
Empty glass columns with 2 glass fiber filter elements, 6 mL	30	730172
Glass fiber filter elements for glass columns 3 mL	250	730191
Glass fiber filter elements for glass columns 6 mL	250	730192
Empty LV polypropylene columns with PE filter elements, 15 mL, for 100 mg adsorbent weight	50	732500
Empty LV polypropylene columns with PE filter elements, 15 mL, for 200/500 mg adsorbent weight	50	732501
PE filter elements for LV polypropylene columns 15 mL for 100 mg adsorbent weight	250	732019
PE filter elements for LV polypropylene columns 15 mL for 200/500 mg adsorbent weight	250	732020
Adapters (PVDF) for glass columns	4	730104.4
Adapters as above	10	730105
Adapters (PP) for polypropylene columns (1, 3 and 6 mL)	4	730100.4
Adapters as above	10	730101
Adapters (PE) for polypropylene columns (15, 45, 70 mL)	4	730350.4
Adapters as above	10	730385
Adapter (PE) for polypropylene columns (30 and 70 mL)	1	730566
<b>Reservoir columns for application of medium-size samples ⑧ + ⑨</b>		
Reservoir column 30 mL, polypropylene, with one adapter for 1, 3, 6 mL CHROMABOND® polypropylene columns	1	730102
10 Reservoir columns 30 mL, polypropylene, with one adapter for 1, 3, 6 mL CHROMABOND® polypropylene columns	1 kit	730103
Reservoir column 70 mL, polypropylene, with one adapter for 1, 3, 6 mL CHROMABOND® polypropylene columns	1	730381
10 Reservoir columns 70 mL, polypropylene, with one adapter for 1, 3, 6 mL CHROMABOND® polypropylene columns	1 kit	730382
Reservoir column 70 mL, polypropylene, with one adapter for 15, 45, 70 mL CHROMABOND® polypropylene columns	1	730388
10 Reservoir columns 70 mL, polypropylene, with one adapter for 15, 45, 70 mL CHROMABOND® polypropylene columns	1 kit	730389

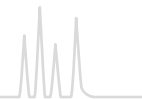

## Automated and on-line SPE

Performing Solid Phase Extraction (SPE) manually can be time consuming and nerve-racking, especially when recovery and reproducibility are lacking due to sample variability. If SPE can be reliably automated it becomes a much more efficient and reproducible process.

On-line SPE is a powerful method in automated sample preparation where the SPE hardware is technically integrated into a HPLC system. Crude samples are placed in an autosampler and processed fully automatically prior to injection into a GC (MS) or LC (MS) system.

MN offers different on-line column configurations designed to fit your on-line SPE needs and filled with a choice of different adsorbents, modifications and particle sizes:

- Ready-to-use EC columns or ChromCart® cartridges for on-line SPE (standard dimensions 20 x 2 mm or 20 x 4 mm, resp.), filled with CHROMABOND® HR-Xpert phases (15 µm particles) or with NUCLEODUR® C<sub>18</sub> ec, C<sub>8</sub> ec, CN (20 µm particles)



EC column



CC-cartridges

- Columns for Gilson® ASPEC™ systems are ready to use assembled with caps. In addition to the columns and phases listed below, all 1, 3 and 6 mL CHROMABOND® polypropylene columns from our program can be supplied assembled with ASP caps.



Columns for the Gilson® ASPEC™

### Ordering information Gilson® ASPEC™ columns

Volume	Adsorbent weight	Pack of [columns]	REF
<b>CHROMABOND® SiOH</b>			
1 mL	100 mg	100	730071ASP
3 mL	500 mg	100	730073ASP
6 mL	1000 mg	100	730075ASP
<b>CHROMABOND® C<sub>18</sub> ec</b>			
1 mL	100 mg	100	730011ASP
3 mL	500 mg	100	730013ASP
6 mL	1000 mg	100	730015ASP

- SPE columns equipped with caps and needles to be used in the SPE unit of the Gerstel MultiPurposeSampler (MPS)



SPE cartridges for Gerstel MPS system



Gerstel MPS system

### Ordering information Gerstel MPS columns

Volume	Adsorbent weight	Pack of [columns]	REF
<b>CHROMABOND® SiOH</b>			
3 mL	200 mg	50	730214MPS
3 mL	500 mg	50	730073MPS
6 mL	1000 mg	30	730075MPS
<b>CHROMABOND® C<sub>18</sub> ec</b>			
1 mL	100 mg	100	730011MPS
3 mL	200 mg	50	730012MPS
3 mL	500 mg	50	730013MPS
<b>CHROMABOND® HR-X</b>			
1 mL	100 mg	30	730935MPS
3 mL	200 mg	30	730931MPS
6 mL	500 mg	30	730939MPS

Other dimensions and adsorbents on request.

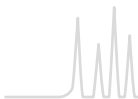

## CHROMABOND® MULTI 96 for robot systems

Alternatively CHROMABOND® MULTI 96 plates provide a means of high throughput sample preparation by processing 96 samples in a standard 8 x 12 microcolumn plate format compatible with standard 96-well plate liquid handling technologies and injection systems. MULTI 96 plates are available for solid phase extraction (SPE) and for filtration (see page 95)

### CHROMABOND® MULTI 96

- 96-well PP microtiter plates with PE filter elements
- Cavity volume 1.5 mL
- Adsorbent weights 10, 25, 50, 100 mg per microcolumn
- Supplied with any CHROMABOND® SPE adsorbents
- For the simultaneous preparation of 96 samples
- Easy method transfer from CHROMABOND® columns or CHROMAFIX® cartridges to CHROMABOND® MULTI 96

### Advantages of this high-throughput system

- Simultaneous preparation of 96 samples; this means a 4-fold increase over traditional 24-position SPE processors
- Economical by saving time and solvent
- Use of multi-channel pipettors facilitates liquid transfer steps
- Readily adaptable to all common automated and robotic handling systems
- Minimized dead volume ( $\leq 40 \mu\text{L}$ )

### Instrument compatibility

CHROMABOND® MULTI 96 SPE microtiter plates as well as CHROMAFIL® MULTI 96 filtration plates are compatible with, e.g., the following liquid handling and SPE automation systems:

- Perkin Elmer MultiProbe® II
- Tomtec Quadra 3® and Quadra 3® SPE
- Hamilton Microlab® SPE Workstation
- Beckman Coulter Biomek® 2000
- Caliper Life Science RapidTrace®
- Gilson® ASPEC™ XL4 and ASPEC™ XL
- Gilson® 215 SPE Liquid Handler
- Tecan Genesis™ FE500
- Eppendorf epMotion®

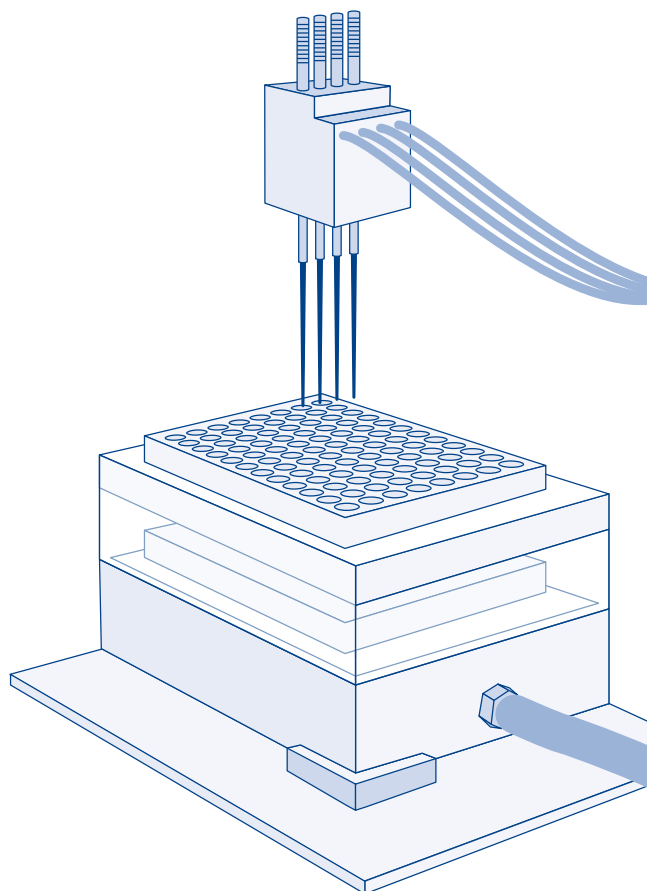

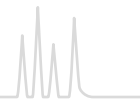

## CHROMABOND® MULTI 96 vacuum manifold

For handling of CHROMABOND® MULTI 96 SPE plates for up to 96 samples

CHROMABOND® MULTI 96 is designed for use in common robotic workstations or commercially available liquid handling systems. Alternatively, use of multichannel pipettors facilitates a manual liquid transfer. Extraction is carried out using the CHROMABOND® MULTI 96 vacuum manifold.

With the help of the control valve the vacuum of the manifold can be adjusted leading to an optimum flow rate through the CHROMABOND® MULTI 96 SPE plate.

A reservoir tank and 96-well collection plates (96 x 0.5 or 96 x 2 mL) made of polypropylene can be supplied as accessories.

An interesting alternative for collection of the eluates is a collection rack, which can be fitted with twelve 8-well strips of polypropylene tubes (each 1 mL).

If you have to work on less than 96 samples, you can seal individual rows of the 96-well plate with a PTFE-covered rubber pad.

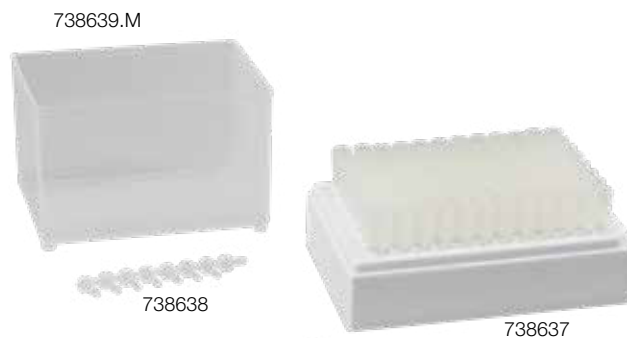

### Ordering information

Description	Pack of	REF
<b>CHROMABOND® MULTI 96 accessories</b>		
CHROMABOND® MULTI 96 vacuum manifold with reservoir tank, vacuum gauge, and control valve	1	738630.M
96-well microtiter plates (polypropylene) 96 x 0.25 mL	10	738651
96-deep-well collecting plate (polypropylene) 96 x 2 mL	5	738650.5
Collection racks with polypropylene tube strips (twelve 8-well strips) 96 x 1.0 mL	5	738637
Polypropylene tube strips (twelve 8-well strips) 96 x 1.0 mL	10	738652
8-well strip sealing caps for PP tube strips (REF 738652)	30	738638
Reservoir tanks (polypropylene)	2	738639.M
Butyl rubber pad, PTFE covered for sealing of individual rows of the 96-well plate, 125 x 85 mm	1	738645

For CHROMAFIL® MULTI 96 filter plates see page 95. The ordering information of 96-well plates packed with individual CHROMABOND® adsorbents is listed with the respective phases.